

JUNIPER®

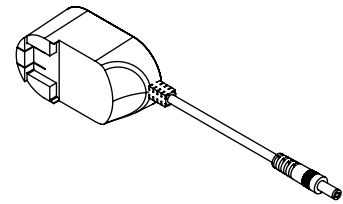

INTERCHANGEABLE PINS

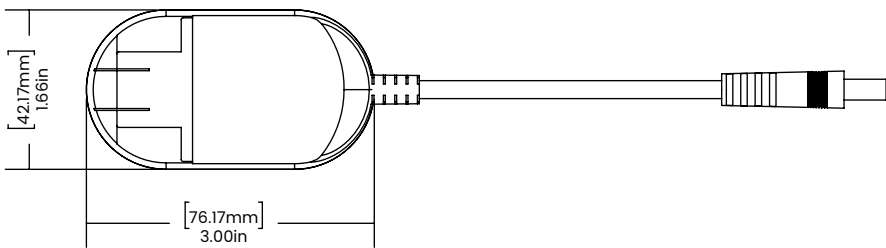
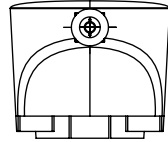
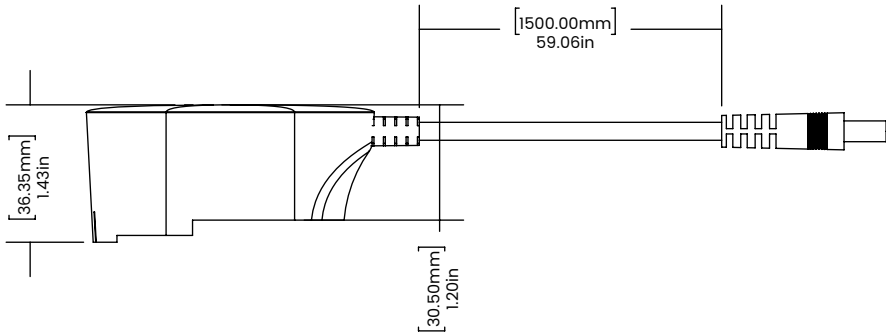
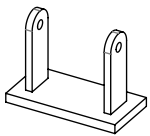

US PINS (TYPE A)

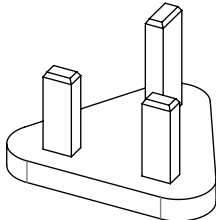

UK PINS (TYPE G)

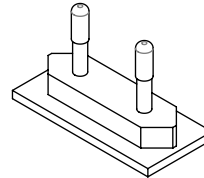

EU PINS (TYPE C)

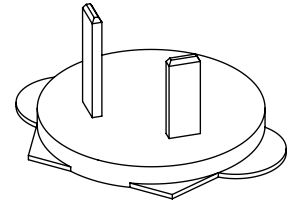

AU PINS (TYPE I)

POWER SUPPLY

12VDC 1A POWER SUPPLY

PWR-0056

OVERVIEW

Plug-In power supply

FEATURES

Class 2 power supply
 Constant output voltage
 Efficiency up to 82.96%
 Conforms to UL60065 and UL60950
 Suitable for dry locations
 Suitable for LED lighting
 Circuit breaker for protection
 Interchangeable International pins available

INPUT

Voltage Range: 90VAC - 264VAC
 Frequency range: 47Hz-63Hz
 Current : 0.35A @ rated voltage
 Power factor: NA
 Efficiency: 82.96% @ rated voltage
 Rated Voltage: 100VAC - 240VAC

OUTPUT

Voltage: 12.0 VDC
 Current : 1A (12VDC)
 Rated power: 12W

ENVIRONMENT

Working temperature: 0°C-40°C

SAFETY AND EMC STANDARDS

UL60065
 UL60950
 ETL Listed

INTERCHANGEABLE PINS OPTIONS

US PINS (TYPE A)
 UK PINS (TYPE G)
 EU PINS (TYPE C)
 AU PINS (TYPE I)

