

# JUNIPER®

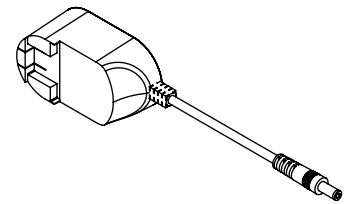

## INTERCHANGEABLE PINS

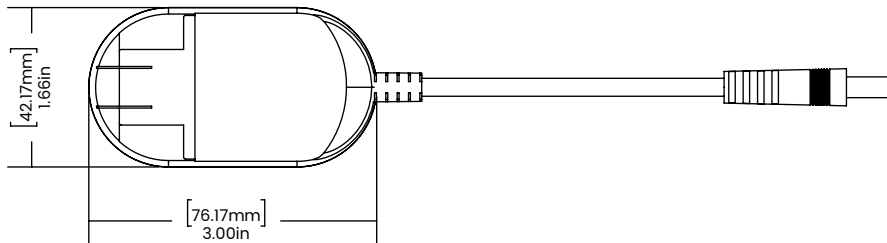
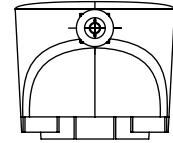
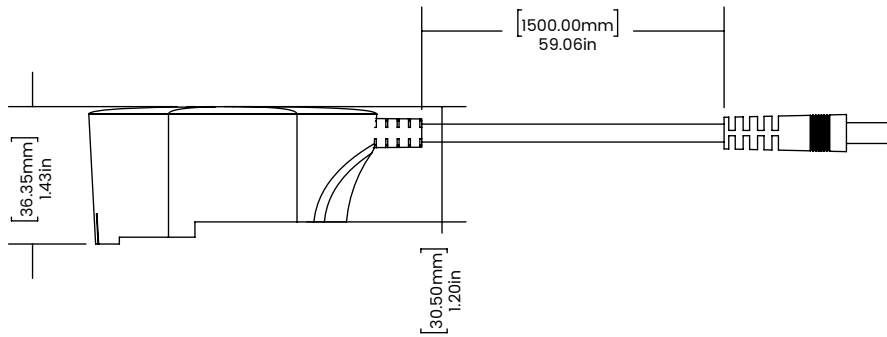
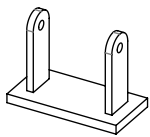

US PINS (TYPE A)

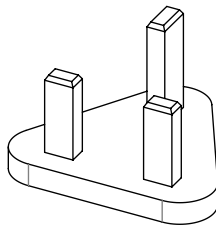

EU PINS (TYPE G)

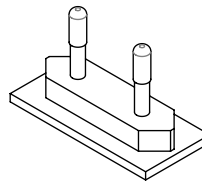

UK PINS (TYPE C)

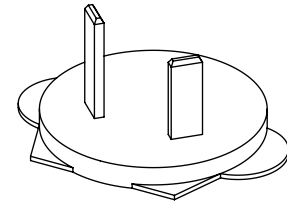

AU PINS (TYPE I)

## POWER SUPPLY

### 12VDC 3A POWER SUPPLY

PWR-0067

#### OVERVIEW

Plug-In power supply

#### FEATURES

Class 2 power supply  
 Constant output voltage  
 Efficiency up to 82.96%  
 Conforms to UL60065 and UL60950  
 Suitable for dry locations  
 Suitable for LED lighting  
 Circuit breaker for protection  
 Interchangeable International pins available

#### INPUT

Voltage Range: 90VAC - 264VAC  
 Frequency range: 47Hz-63Hz  
 Current : 0.36A @ rated voltage  
 Power factor: NA  
 Efficiency: 82.96% @ rated voltage  
 Rated Voltage: 100VAC - 240VAC

#### OUTPUT

Voltage: 12.0 VDC  
 Current : 3A (12VDC)  
 Rated power: 36W

#### ENVIRONMENT

Working temperature: 0°C-40°C

#### SAFETY AND EMC STANDARDS

UL60065  
 UL60950  
 ETL Listed

#### INTERCHANGEABLE PINS OPTIONS

US PINS (TYPE A)  
 EU PINS (TYPE G)  
 UK PINS (TYPE C)  
 AU PINS (TYPE I)

